

RL40-M6-40

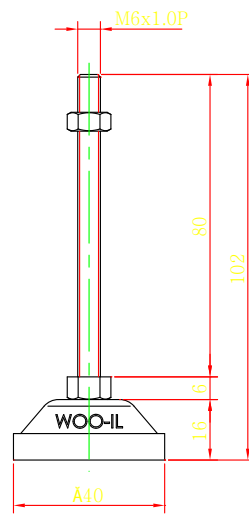

RL40-M6-80

No.	PART		MATERIAL	Q'TY	REMARK	
SIZE	A3	DESIGNED	CHECKED	APPROVED	DATE	ITEM
UNIT	mm	US.Hwang	HJ.Kim	HJ.Kim	21.01.06	RL40-M6
SCALE	1 : 1					

WOO - IL INDUSTRY Co., Ltd

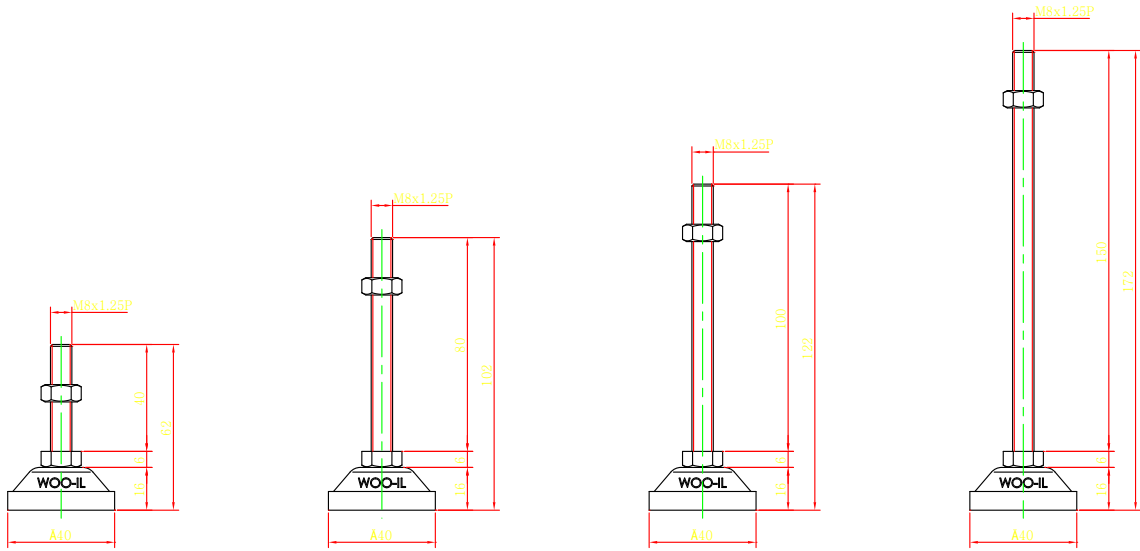

RL40-M8-40

RL40-M8-80

RL40-M8-100

RL40-M8-150

No.	PART		MATERIAL	Q'TY	REMARK	
SIZE	A2	DESIGNED	CHECKED	APPROVED	DATE	ITEM
UNIT	mm	US.Hwang	HJ.Kim	HJ.Kim	21.01.06	RL40-M8
SCALE	1 : 1					

WOO - IL INDUSTRY Co., Ltd

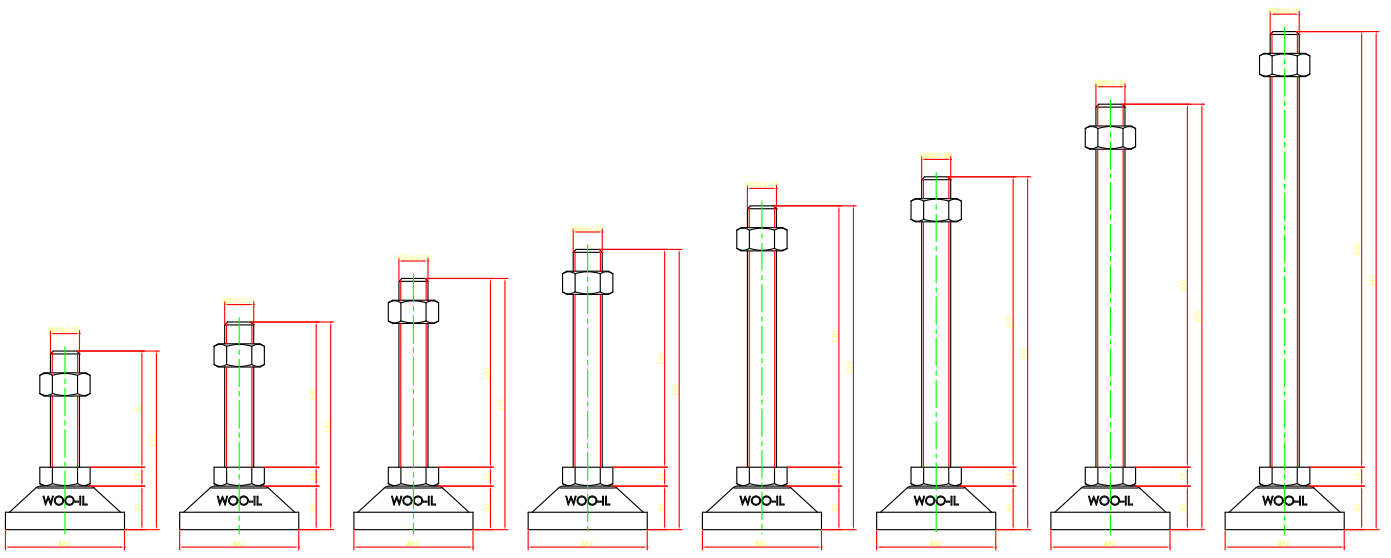

RL82-M20-80 RL82-M20-100 RL82-M20-130 RL82-M20-150 RL82-M20-180 RL82-M20-200 RL82-M20-250 RL82-M20-300

No.	PART	MATERIAL	QTY	REMARK
SIZE	A1	DESIGNED	CHECKED	APPROVED
UNIT	mm	US.Hwang	HJ.Kim	HJ.Kim
SCALE	1 : 1			21.01.15
				RL82-M20

WOO - IL INDUSTRY Co., Ltd

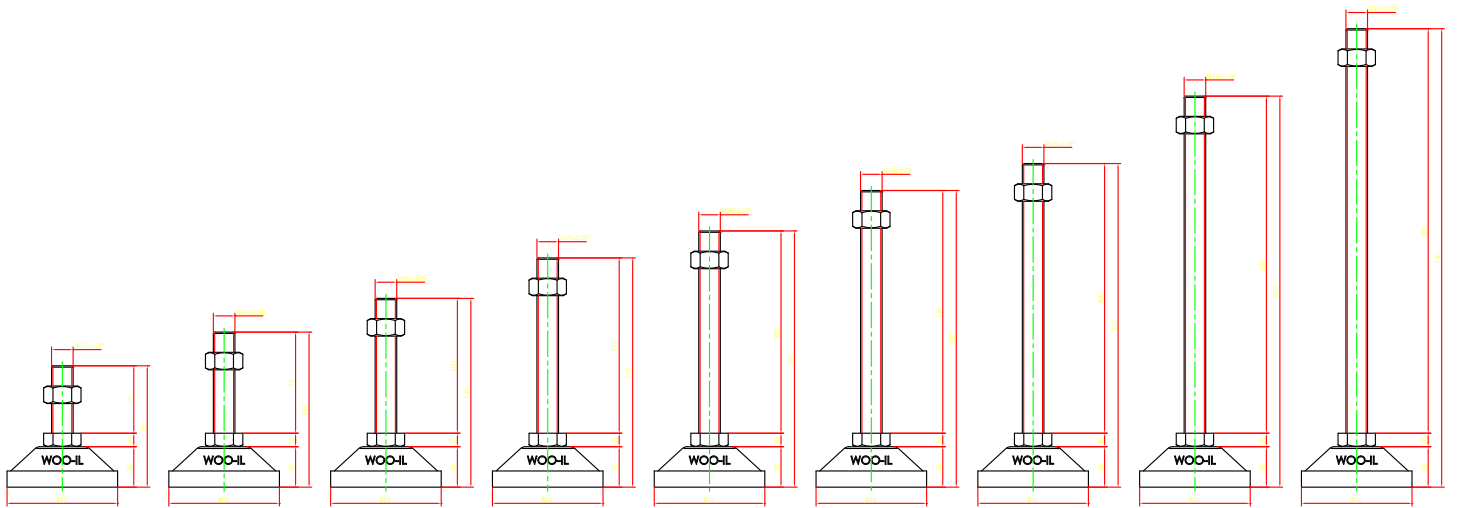

RL82-M16-50 RL82-M16-75 RL82-M16-100 RL82-M16-130 RL82-M16-150 RL82-M16-180 RL82-M16-200 RL82-M16-250 RL82-M16-300

No.	PART	MATERIAL	Q'TY	REMARK		
SIZE	A1	DESIGNED	CHECKED	APPROVED	DATE	ITEM
UNIT	mm	U.S.Hwang	H.J.Kim	H.J.Kim	21.01.09	RL82-M16
SCALE	1 : 1					

WOO - IL INDUSTRY Co., Ltd

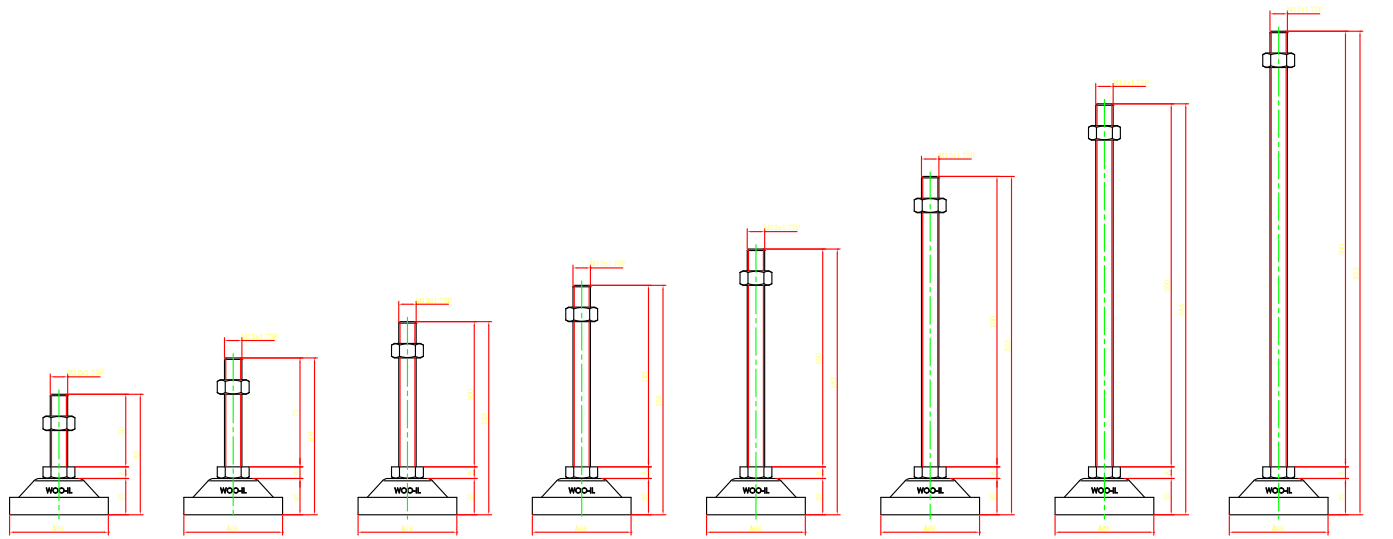

RL68-M12-50

RL68-M12-75

RL68-M12-100

RL68-M12-125

RL68-M12-150

RL68-M12-200

RL68-M12-250

RL68-M12-300

No.	PART	MATERIAL	QTY	REMARK		
SIZE	A1	DESIGNED	CHECKED	APPROVED	DATE	ITEM
UNIT	mm	US.Hwang	HJ.Kim	HJ.Kim	21.01.05	RL68-M12
SCALE	1 : 1					

WOO - IL INDUSTRY Co., Ltd

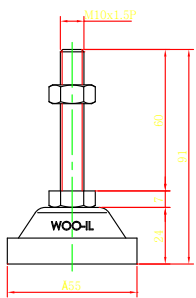

RL55-M10-60

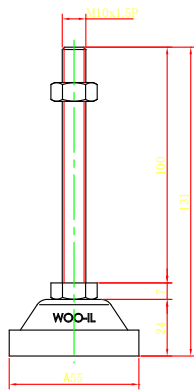

RL55-M10-100

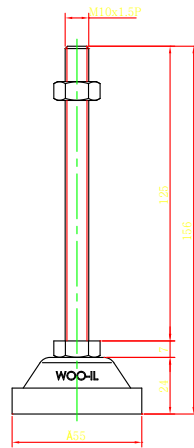

RL55-M10-125



RL55-M10-150

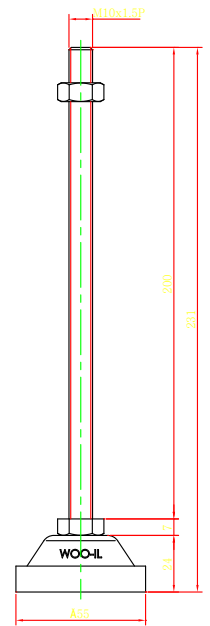

RL55-M10-200

No.	PART	MATERIAL	Q'TY	REMARK		
SIZE	A2	DESIGNED	CHECKED	APPROVED	DATE	ITEM
UNIT	mm	US.Hwang	HJ.Kim	HJ.Kim	21.01.06	RL55-M10
SCALE	1 : 1					

WOO - IL INDUSTRY Co., Ltd